

LumiSheet

Original LED Light Panel









*Double Face Illumination Available

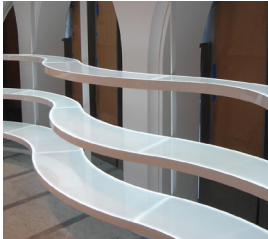

LumiSheet has revolutionized retail and architectural lighting. This frameless, edge-lit LED light panel produces a bright, even light across its entire surface. It can be ordered in any shape, size, and color and can be put virtually anywhere. Behind graphics. On walls. On ceilings. On floors. As lit shelving. The applications are endless.

LumiSheet is lasting, brilliant, and adaptable.

FEATURES

 <p>Custom Applications</p>	<ul style="list-style-type: none"> ✓ Available in custom sizes, shapes, and curves ✓ Full color customization ✓ Frameless ✓ Slim (8 mm, or 6 mm thick) ✓ 3D v-cutting technology ✓ High brightness (up to 10 000 lux) ✓ High CRI available ✓ Long LED lifespan (70 000+ hours) ✓ Energy saving and maintenance free (70% energy savings over traditional lighting) ✓ Superior consistent light quality ✓ Advanced 3-year warranty 	 
 <p>Lit Walls</p>		
 <p>Lit Ceilings</p>		
 <p>Lit Fixturing</p>		
 <p>Lit Shelving</p>		



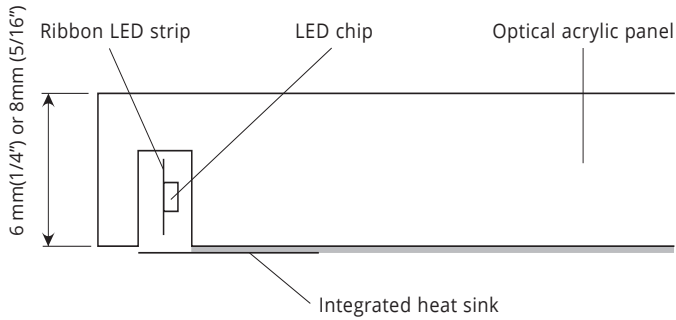

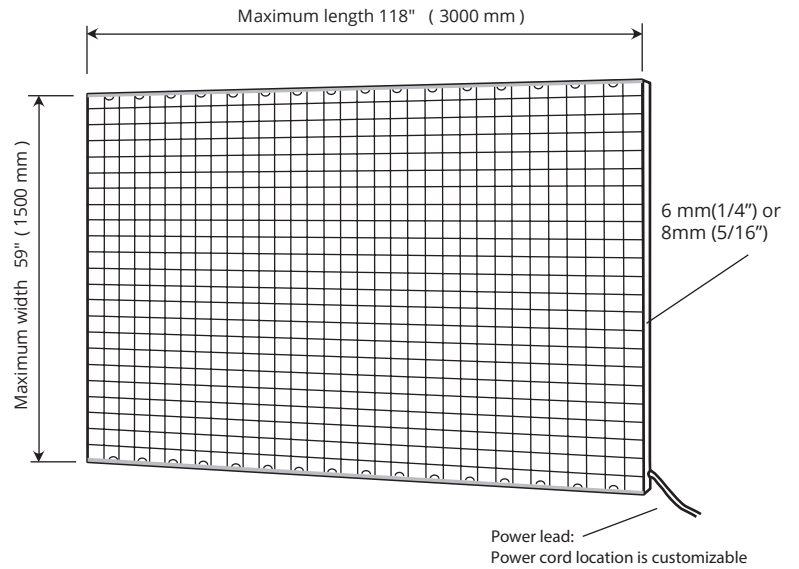

PROFILE VIEW



FRONT VIEW



SPECIFICATIONS

Electrical			
Input Voltage	12 V DC / 24V DC	12V DC	12V DC
	Standard	CCT	RGB
Power Consumption	4.0 W/ft	5.0 W/ft	5.0 W/ft 4.3 W/ft (static red, static green, or static blue)
Wire Size	20 AWG 2 wire	20 AWG 3 wire	22 AWG 4 wire
Wiring	Each panel must have direct connection to power supply. Do not wire panels in series		
Connector	Standard 5' (1500 mm), 10' (3000 mm) or custom		
	2.1 / 5.5 mm barrel plug	Bare wire or custom molex connector	Bare wire
Certification	UL recognized component (E362079), UL listed (E346146)		
Physical			
Color Temperature	Standard	CCT	RGB
	3000 K  3500 K  4100 K 	5300 K  6300 K 	CCT (2700 K - 6500 K) 
Standard CRI	80		
High CRI	≥ 90 available (12 VDC only) in 3000 K, 4100 K, 5300 K		
Mounting	Mounted with screws, Z-clips or edge clips / standoffs		
Lumen Output (lm/W)	88 (3000 K), 98 (3500 K), 100 (4100 K), 106 (5300 K), 99 (6300 K)		
Operating Temperature	-30 °C (-22°F) ~ +40 °C (+104 °F)		
Environment	Dry location only (indoor)		
Thickness	5/16" (8 mm) / 6mm	8 mm	8 mm
Minimum Size	2" (50 mm) L x 2" (50 mm) W		
Maximum Size	118" (3000 mm) L x 59" (1500 mm) W		
Weight	1.95 lbs / sq ft (9.54 kg / sq m)		

SPECIFICATIONS BY SIZE

Size (inch)	Size (mm)	LED Strip	Average Surface Brightness (Lx)	Power Consumption (W)
6 x 6	150 x 150	1 side	6000	2
12 x 12	300 x 300	1 side	3000	4
24 x 24	600 x 600	2 sides	3200	15
36 x 36	900 x 900	2 sides	2600	23
48 x 48	1200 x 1200	2 sides	2200	30
48 x 96	1200 x 2400	2 sides	2200	60
Ø 6	Ø 152	all around	19 000	5.8
Ø 12	Ø 300	all around	13 000	11.2
Ø 24	Ø 600	all around	5400	24
Ø 36	Ø 900	all around	4500	36
Ø 48	Ø 1200	all around	3500	48

ORDER INFORMATION

Series #	Size	Color Temperature		Illuminated Face Option	Cable Length	LED Location
LLP12 8 mm depth 12 V 6mm	CS: Custom shape (drawing may be required)	3000 K	CCT (2700 K - 6500 K)	SFI: Single face DFI: Double face	WL15: 5' (1500 mm) power cord with 2.1 / 5.5 mm barrel plug	L1: LEDs along 1 long edge L2: LEDs along 2 long edges S1: LEDs along 1 short edge S2: LEDs along 2 short edges S4: LEDs along all 4 edges CI: Custom illumination
LLP24 8 mm depth 24 V 6mm		3500 K 4100 K 5300 K 6300 K				

TYPICAL SURFACE BRIGHTNESS MEASURE

Brightness readings are for reference only.
Actual reading may differ for different LEDs,
LGPs or even different meters

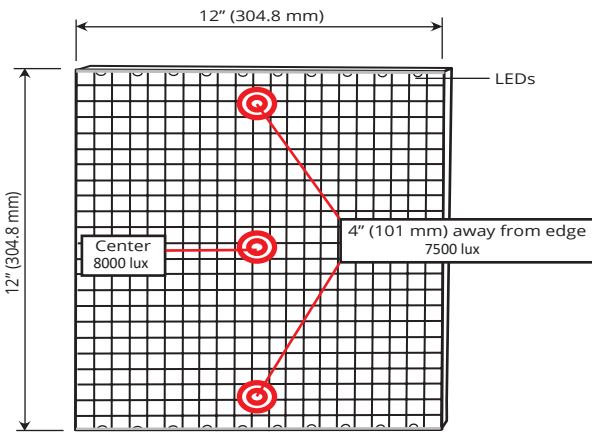

12" (304.8 mm) x 12" (304.8 mm) LumiSheet with 5300 K LEDs lit along 2 long edges (8 W)

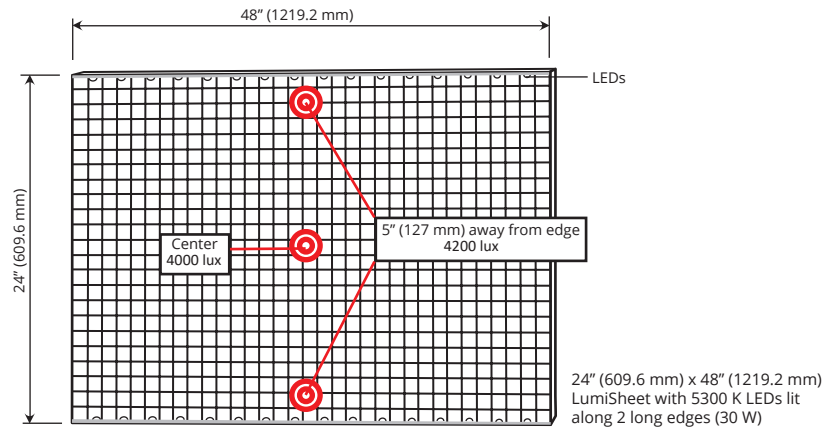

24" (609.6 mm) x 48" (1219.2 mm) LumiSheet with 5300 K LEDs lit along 2 long edges (30 W)

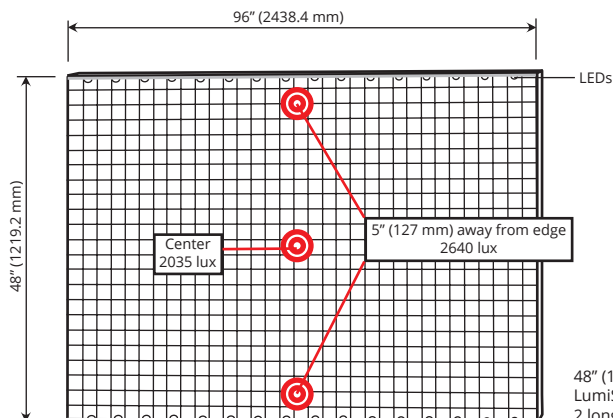

48" (1219.2 mm) x 96" (2438.4 mm) LumiSheet with 5300 K LEDs lit along 2 long edges (60 W)

TYPICAL POWER CORD EXITS

Standard 1

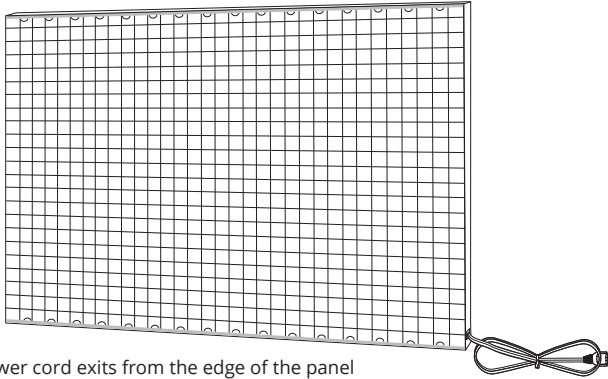

Power cord exits from the edge of the panel

Standard 2

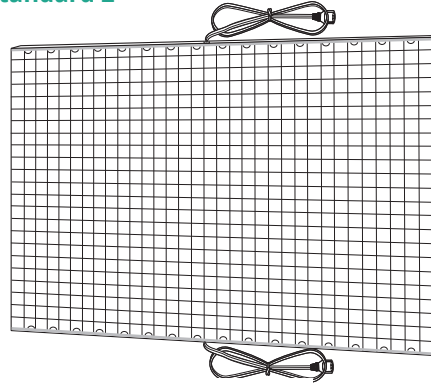

For LumiSheet longer than 6', the power cord exits from the middle of each long side out edge

Option 1

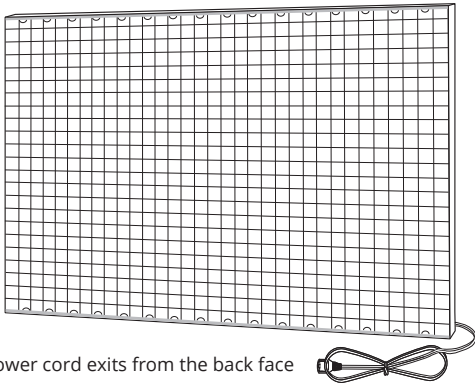

Power cord exits from the back face

Option 2

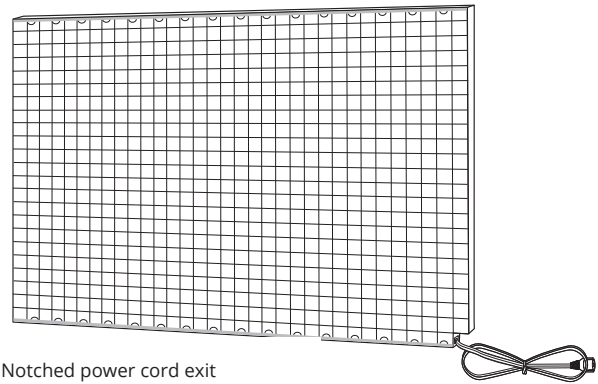

Notched power cord exit