

Lumi Light Box #28 Textura

Wood Framed LED Light Box



Textura is an LED light box that surrounds LumiSheet with a custom top loading wood frame. The result is beautifully simple. Choose from seven contemporary wood finishes in your preferred frame thickness. Available in curved shapes at any size, including round LED light boxes.

FEATURES

- ✓ Any size
- ✓ Any shape
- ✓ Wooden frame with custom width
- ✓ Unique finishes
- ✓ Top loading for quick graphic changes
- ✓ Super bright
- ✓ Easy to install
- ✓ Energy saving and maintenance free
- ✓ Superior consistent light quality
- ✓ Advanced 3-year warranty





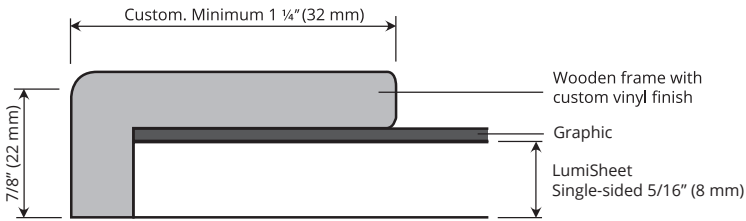

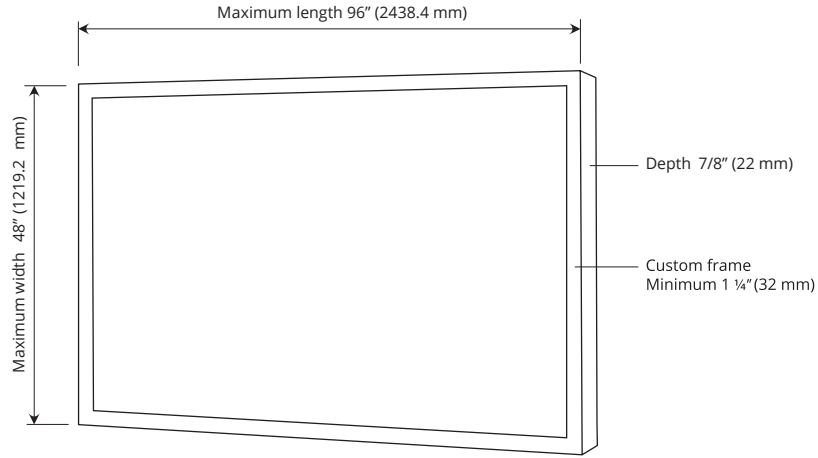

PROFILE VIEW



FRONT VIEW



SPECIFICATIONS						
Electrical						
Input Voltage	12 VDC		24 VDC (optional)			
Power Consumption	4.0 W/ft (standard), 5.0 W/ft (high output)					
Wire Size	20 AWG 2 wire					
Wiring	Each light box must have direct connection to power supply. Do not wire light boxes in series					
Connector	2.1 / 5.5 mm barrel plug. Standard 5' (1500 mm), optional 10' (3000 mm)					
Certification	UL listed (E346146) for LumiSheet embedded					
Physical						
Color Temperature	3000 K 	3500 K 	4100 K 	5300 K 	6300 K 	CCT 
High CRI	≥ 90 available (12 VDC only) in 3000 K, 4100 K, 5300 K					
Mounting	Wall mounted with z-bars					
Operating Temperature	-30 °C (-22 °F) ~ +40 °C (+104 °F)					
Environment	Dry location only (standard)					
Minimum Size	6" (76 mm) L x 6" (76 mm) W					
Maximum Size	96" (2438.4 mm) L x 48" (1219.2 mm) W					
Thickness	7/8" (22 mm)					
Weight	Approx. 3.2 lbs / sq ft (15 kg / sq m)					
Frame						
Frame Width	Custom. Minimum 1 ¼" (32 mm)					
Frame Material	Wooden frame with custom vinyl finish					
Frame Finishes	White / Dune / Natural / Honey / Sun Bleached / Rustic / Mocha					

ORDER INFORMATION						
Series #	Frame Color	Size: Length x Width (inch/mm)	Color Temperature	Illuminated Face Option	Cable Length	LED Location
LLB12-28 LLB24-28	OMS-3: Mocha OMS-4: Sun Bleached OMS-6: Rustic 68-24: Honey 68-58: Dune 8042: White 8807: Natural	Rectangle: (Length x Width) Circle	3000 K 3500 K 4100 K 5300 K 6300 K CCT (3000 K - 6500 K) High CRI	SFI: Single face	WL15: 5' (1500 mm) power cord with 2.1 / 5.5 mm barrel plug WL30: 10' (3000 mm) power cord with 2.1 / 5.5 mm barrel plug	L1: LEDs along 1 long edge L2: LEDs along 2 long edges S1: LEDs along 1 short edge S2: LEDs along 2 short edges S4: LEDs along all edges

- Notes:
- Acrylic and other manufacturing components and methods may contribute to an expansion or contraction of sizes based on environmental or tooling factors. Please allow a minimum of ± 1/8" (3.175 mm) to compensate for any changes in the outside dimensions of this product
 - Our tunable white LEDs utilize separate warm and cool white channels for color mixing. 3rd party controls must account for proportional balancing/mixing of the two channels. Example: 3000 K (Warm White) = 3000 K 100% ON & 6500 K (Ultra White) OFF, Balancing/Mixing of both = 3000 K 50% ON & 6500 K 50% ON, 6500 K = 3000 K OFF & 6500 K 100% ON. Both channels cannot be allowed to operate at 100% simultaneously as the LED are not engineered to handle such high current
 - LED Kelvin temperatures listed in this literature have been derived from raw LED data. Actual Kelvin ratings can vary +/- 200 K based upon environmental conditions including but not limited to inclusion into LGPs and the use of diffusion materials. A precise ANSI bin control system is utilized to help maintain LED conformity and to minimize variances
 - DLC strives to maintain tight control over specification factors. However, specifications are subject to change on rare occasion. These changes may not be reflected here